



Evolution of the Sweetness Receptor in Primates.

II. Gustatory Responses of Non-human Primates to Nine Compounds Known to be Sweet in Man

C. Nofre, J. M. Tinti and D. Glaser¹

Université Claude Bernard, Faculté de Médecine Alexis Carrel, Laboratoire de Biochimie Structurale, Rue Guillaume Paradin, 69008 Lyon, France and ¹Anthropological Institute, University of Zürich-Irchel, Winterthurerstrasse 190, 8057 Zürich, Switzerland

Correspondence to be sent to: D. Glaser, Anthropological Institute, University of Zürich-Irchel, Winterthurerstrasse 190, 8057 Zürich, Switzerland

Abstract

The gustatory responses of nine compounds, namely glycine, D-phenylalanine, D-tryptophan, cyanosuosan, magapame, sucrononate, campame, cyclamate and superaspartame, all known as sweet in man, were studied in 41 species or subspecies of non-human primates, selected among Prosimii (Lemuridae and Lorisidae), Platyrrhini (Callitrichidae and Cebidae) and Catarrhini (Cercopithecidae, Hylobatidae and Pongidae). The first six compounds are generally sweet to all primates, which implies that they interact with the primate sweetness receptors essentially through *constant* recognition sites. Campame is sweet only to Cebidae and Catarrhini, cyclamate only to Catarrhini, superaspartame principally to Callitrichidae and Catarrhini, which implies that all these compounds interact with the receptors partly through *variable* recognition sites. From the present work, from other previous results (where notably it was observed that alitame is sweet to all primates, ampame only to Prosimii and Catarrhini, and aspartame only to Catarrhini), and from the multipoint attachment (MPA) theory of sweetness reception (as elaborated by Nofre and Tinti from a detailed study of structure–activity relationships of various sweeteners in man), it is inferred that the primate sweetness receptors are very likely made up of eight recognition sites, of which the first, second, third, fourth, seventh and eighth are constant, and the fifth and sixth variable. From these results and from the MPA theory, it is also inferred that the recognition sites of the primate sweetness receptors could be: Asp-1 or Glu-1, Lys-2, Asp-3 or Glu-3, Thr-4, X-5, X-6, Thr-7, Ser-8, where the variable recognition sites X-5 and X-6 would be: Ala-5 and Ala-6 for Callitrichidae, Ser-5 and Ala-6 for Cebidae, Ala-5 and Thr-6 for Prosimii, and Thr-5 and Thr-6 for Catarrhini. By using Tupaiidae (tree shrews) as a reference outgroup and by means of other structural and functional molecular considerations, it appears that Callitrichidae have retained the most primitive receptor among the four types of primate receptors. The possible taxonomic and phylogenetic implications of these findings are discussed.

Chem. Senses 21: 747–762, 1996.

Introduction

Although aspartame (APM; Figure 1a) and alitame (ALT; Figure 1b), two dipeptide derivatives both sweet in man, have related structures (they are both based on L-aspartic acid), APM turns out to be sweet only in Old World simians, while ALT is sweet in *all* primates (Glaser *et al.*, 1995a). These gustatory response differences were interpreted as being due to the presence, in the sweetness receptor of Old World simians, of two different 'hydrophobic' recognition sites, one able to recognize the 'hydrophobic' group of APM (i.e. its phenyl group), and the other able to recognize the 'hydrophobic' group (the tetramethylthietanyl group) of ALT; in prosimians and in New World monkeys, only the 'hydrophobic' recognition site of ALT is present (Glaser *et al.*, 1995a). Consequently, to explain the coexistence in Old World simians of both the specific recognition sites of ALT and APM, it was necessary to assume that both these compounds must interact with the receptor via two different active conformations: ALT in an L-shaped conformation, and APM in an extended conformation (Glaser *et al.*, 1995a).

Recently, in order to try to understand, at the molecular level, the reasons for the differences observed between APM and ALT in primate responses, we experimented with six other dipeptide derivatives or analogues (all based on L-aspartic acid and all able to induce a sweet taste in man) on 24 selected non-human primate species or subspecies (Glaser *et al.*, 1995b, 1996). We noticed that these compounds can be divided up into three classes according to their gustatory responses in primates: (i) compounds which are sweet to all primates (prosimians, New World monkeys and Old World simians), such as ALT or L-aspartyl-D-alanine propyl ester; (ii) compounds which are sweet to prosimians and Old World simians, but not to New World monkeys, such as L-aspartyl-(*R*)- α -methyl-phenethylamine (ampame) or L-aspartyl-L-(*O*-*tert*-butyl)-serine methyl ester; and (iii) compounds which are sweet only to Old World simians, but not to prosimians and New World monkeys, such as APM. Analysis of these results by means of the multipoint attachment (MPA) theory of sweetness reception in man (Nofre and Tinti, 1995, 1996) suggests that the seven basic recognition sites of the sweetness receptor in primates, as inferred from the MPA theory, could be (i) in prosimians: Asp-1 or Glu-1, Lys-2, Asp-3 or Glu-3, Thr-4, Ala-5 or Ser-5, Thr-6, Thr-7; (ii) in New World monkeys: Asp-1 or Glu-1, Lys-2, Asp-3 or Glu-3, Thr-4, Ala-5 or Ser-5, Ala-6

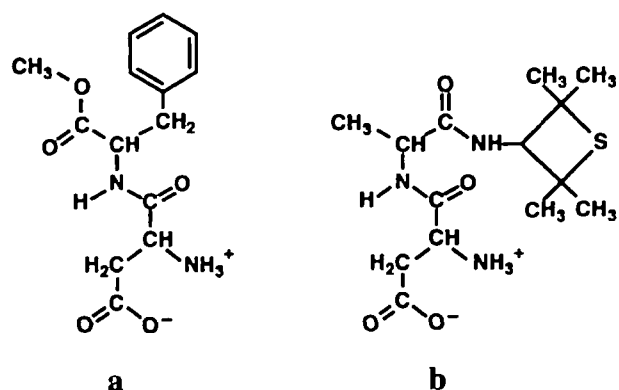

Figure 1 (a) Aspartame (APM) and (b) alitame (ALT).

or Ser-6, Thr-7; and (iii) in Old World simians: Asp-1 or Glu-1, Lys-2, Asp-3 or Glu-3, Thr-4, Thr-5, Thr-6, Thr-7 (Glaser *et al.*, 1996).

The purpose of the present work has been to test nine additional compounds, all sweet in man, on 41 selected non-human primate species or subspecies, and to analyse the observed gustatory responses by means of the MPA theory in order to contribute to improved understanding of the primate sweetness receptors.

Materials and methods

Chemicals

The nine representative compounds studied in the present work, with a view to observing their gustatory responses in primates, are as follows:

Glycine (Gly) (Figure 2a), an amino acid well known to be sweet to man, has a sweetness potency in man of ~ 0.65 times that of sucrose (in the present work, the sweetness potencies are always given on a weight basis, relative to a 2% sucrose solution). This compound was obtained from a commercial source (Sigma glycine-free base) and was tested in primates at a concentration of 66.68 g/l.

D-Phenylalanine (D-Phe) (Figure 2b), another amino acid known to be sweet to man, has a sweetness potency in man of ~ 6 times that of sucrose. This compound was obtained from a commercial source (Sigma D-phenylalanine) and was tested in primates at a concentration of 5 g/l.

D-Tryptophan (D-Trp) (Figure 2c), another amino acid known to be sweet to man, has a sweetness potency in man of ~ 50 times that of sucrose. This compound was obtained

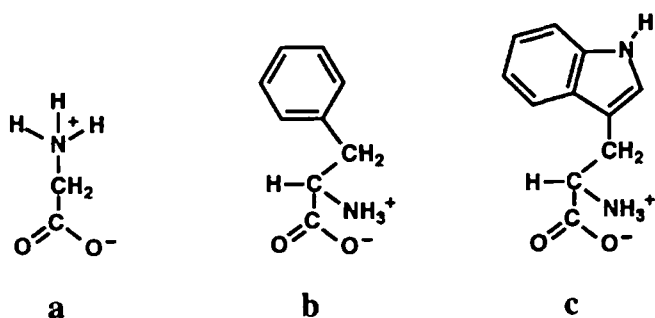

Figure 2 (a) Glycine (Gly), (b) D-phenylalanine (D-Phe) and (c) D-tryptophan (D-Trp).

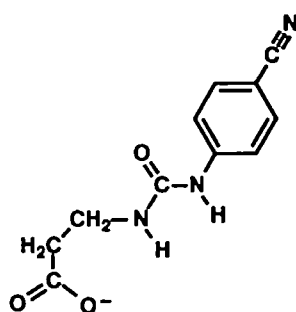

Figure 3 Cyanosuosan.

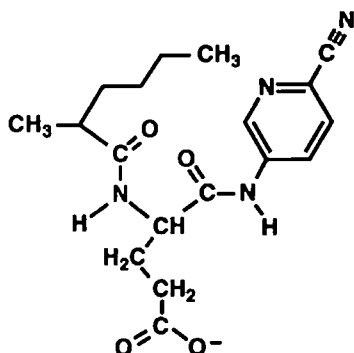

Figure 4 Magapame (MAGAP).

from a commercial source (Sigma D-tryptophan) and was tested in primates at a concentration of 2.98 g/l.

Cyanosuosan (Figure 3), a structural analogue of suosan (Petersen and Müller, 1948), has a sweetness potency in man of ~650 times that of sucrose (Tinti *et al.*, 1982). This compound, prepared as described by Tinti *et al.* (1982), was tested in primates at a concentration of 450 mg/l.

N-[(*S*)-2-Methylhexanoyl]- α -L-glutamyl-5-amino-2-pyridine-carbonitrile (MAGAP or magapame; Figure 4) (Nofre and Tinti, 1994), a sweetener derived from L-glutamic acid, is ~20 000 times sweeter than sucrose in man. This compound, prepared as described by Nofre and Tinti (1994), was tested in primates at a concentration of 40 mg/l.

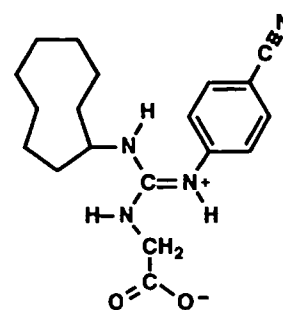

Figure 5 Sucrononate.

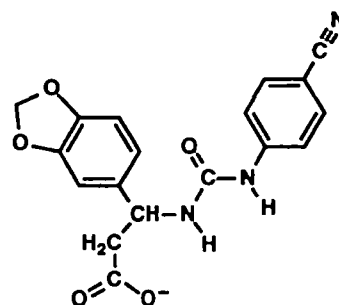

Figure 6 Campame (CAMPA).

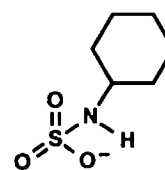

Figure 7 Cyclamate (Cyc).

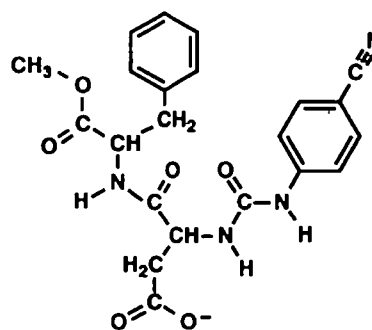

Figure 8 Superaspartame (SAPM).

Sucrononate (Figure 5), a guanidine sweetener, is ~200 000 times sweeter than sucrose in man (Nofre *et al.*, 1990). This compound, prepared as described by Nofre *et al.* (1990), was tested in primates at a concentration of 10 mg/l.

N-(4-Cyanophenylcarbamoyl)-(*RS*)-3-amino-3-(3,4-methylenedioxyphenyl)propionic acid (CAMPA or campame; Figure 6) (Madigan *et al.*, 1989; Müller *et al.*, 1991), a

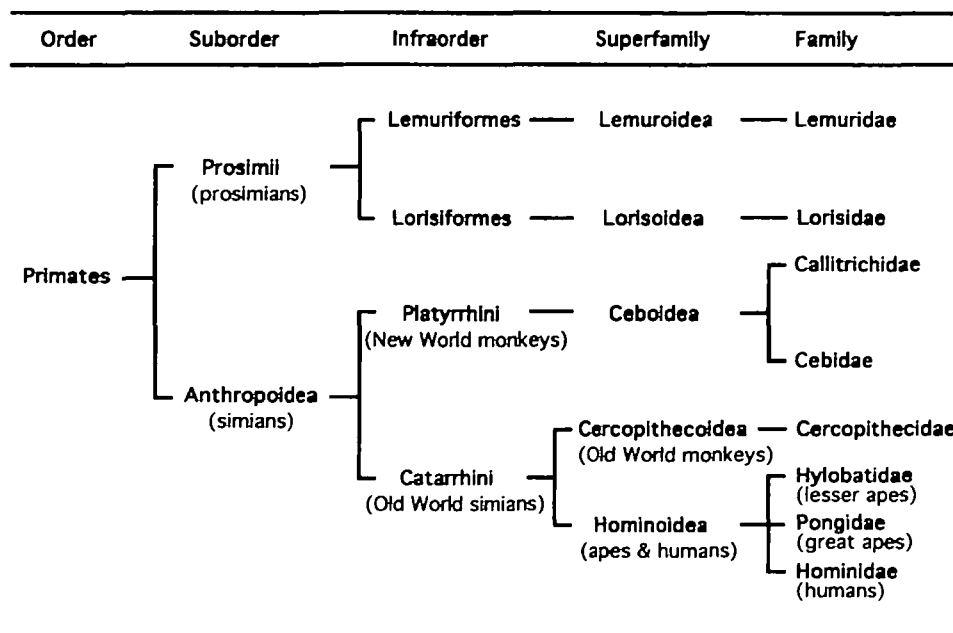

Figure 9 Simplified classification of the living primates used in the present work, based on Simons (1972); also see Martin (1990) and Conroy (1990). For other alternative classifications, see Conroy (1990). The families Cheirogaleidae, Indriidae, Daubentonidae (of the superfamily Lemuroidea, infraorder Lemuriformes, suborder Prosimii) and Tarsiidae (of the superfamily Tarsiioidea, infraorder Tarsiiformes, suborder Prosimii), which have not been studied in the present work, have been excluded from this simplified classification. Common names for some taxonomic groups are given in parentheses for ease of reference.

sweetener derived from β -alanine, is ~15 000 times sweeter than sucrose in man (Nofre and Tinti, 1996). This compound, prepared as described by Madigan *et al.* (1989), was tested in primates at a concentration of 50 mg/l.

Cyclamate (Cyc; Figure 7) (Audrieth and Sveda, 1944) has a sweetness potency in man of ~40 times that of sucrose. This compound was obtained from a commercial source (Sigma cyclamic acid sodium salt) and was tested in primates at a concentration of 5 g/l.

N-(4-Cyanophenylcarbonyl)-L-aspartyl-L-phenylalanine methyl ester (superaspartame or SAPM; Figure 8) (Nofre and Tinti, 1987), a molecular hybrid between APM and cyanosucrose, has a sweetness potency in man of ~8000 times that of sucrose. This compound, prepared as described by Nofre and Tinti (1987), was tested in primates at a concentration of 40 mg/l.

Animals

The above nine representative compounds were tested on 41 selected non-human primate species or subspecies (see Figure 9 for a simplified classification of the primates used in the present study).

In the Lemuridae (lemurs, from Madagascar), we used *Eulemur coronatus* (crowned lemur), *E. fulvus albifrons* (white-fronted brown lemur), *E. macaco macaco* (black lemur), *E. macaco flavifrons* (Sclater's lemur), *E. mongoz*

(mongoose lemur), *E. rubriventer* (red-bellied lemur), *Haplemur griseus occidentalis* (western gentle lemur), *Lemur catta* (ring-tailed lemur), *Varecia variegata variegata* (black-ruffed lemur) and *V. variegata rubra* (red-ruffed lemur).

In the Lorisiidae (from Africa and South-East Asia), we used *Galago senegalensis* (lesser bushbaby) and *Nycticebus pygmaeus* (pygmy slow loris).

In the Callitrichidae (marmosets and tamarins, from South and Central America), we used *Callimico goeldii* (Goeldi's monkey), *Callithrix jacchus jacchus* (common marmoset), *C. jacchus geoffroyi* (white-fronted marmoset), *Cebuella pygmaea* (pygmy marmoset), *Leontopithecus rosalia rosalia* (golden lion tamarin), *L. rosalia chrysomelas* (golden-headed tamarin), *Saguinus imperator subgriseus* (emperor tamarin) and *S. labiatus labiatus* (white-lipped tamarin).

In the Cebidae ('true New World monkeys', from South and Central America), we used *Aotus trivirgatus* (owl or night monkey), *Ateles geoffroyi* (black-handed spider monkey), *Cebus apella xanthosternos* (yellow-breasted capuchin monkey) and *Saimiri sciureus* (common squirrel monkey).

In the Cercopithecidae (Old World monkeys, from Africa and South-East Asia), we used *Allenopithecus nigroviridis* (Allen's swamp monkey), *Cercopithecus diana rolaway*

(Roloway guenon), *C. preussi* (Preuss's guenon), *Erythrocebus patas patas* (patas monkey), *Macaca arctoides* (stump-tailed macaque), *M. nigra* (Celebes black macaque), *Papio anubis* (olive baboon), *P. hamadryas* (hamadryas baboon), *P. papio* (Guinea baboon) and *Presbytis entellus* (Hanuman langur).

In the Hylobatidae (lesser apes, from South-East Asia), we used *Hylobates pileatus* (pileated gibbon) and *H. syndactylus* (siamang).

In the Pongidae (great apes, from Africa and South-East Asia), we used *Gorilla gorilla gorilla* (western lowland gorilla), *Pan paniscus* (pygmy chimpanzee), *P. troglodytes troglodytes* (common chimpanzee), *Pongo pygmaeus pygmaeus* (Borneo orang-utan) and *P. pygmaeus abelii* (Sumatra orang-utan).

Finally, in the family Tupaiidae (tree shrews, from South-East Asia), order Scandentia (see e.g. Corbet and Hill, 1991; Wilson, 1993), we used, as an *outgroup* to primates, *Tupaia belangeri*; this taxonomic group, known to be closely related to Primates (see e.g. Lockett, 1980; Martin, 1990), was used in order to try to infer, by 'outgroup comparison', which primate sweetness receptor could have retained the most primitive (plesiomorphic) character state.

Methods

As we wished to use a large variety of animal species to try to understand the evolution of the sweetness receptor in primates, and on account of the rarity of certain species used (these being, furthermore, often endangered or protected), it was evidently impossible for us to employ conventional electrophysiological recordings from the chorda tympani nerve or conditioned taste aversion tests. In accordance with our own ethic, and the guiding principles in the care and use of animals, we used, in this study, only two complementary behavioural tests: the taste-induced hedonic modification of facial expressions and the two-bottle preference test.

Taste-induced facial expressions clearly show that sweet gustatory stimuli trigger behavioural responses which truly mirror 'hedonic aspects' of gustatory experience (Steiner and Glaser, 1984, 1995): sampling-sipping, lapping or eager drinking, quick swallow, mouth open, lips apart, sucking-smacking, head oriented towards stimulus. These behaviour patterns are clearly differentiable from those triggered by other qualities or simply by tap water (e.g. mouth corners down, spitting, head turn/head shake, gaping, head withdrawal from stimulus). Nearly all primates tested

showed these patterns and this behaviour is not species specific.

The two-bottle preference test, combined with the preceding behavioural observations, was employed to confirm preference for (+), no response to or avoidance of (–) the test solution against tap water. The smaller animals were offered the choice of two bottles attached to the cage. The medium-sized animals were provided with two large drinking bowls, which were placed inside the cages. The apes were tested with the aid of their usual drinking mugs. Thus all animals were able to choose between the solution of the tested compounds and tap water. We randomly swapped around the position of the drinking receptacles. The tests starting early in the morning. The animals had been deprived of fluid intake since the evening before, and so each animal was in a thirsty condition. Finally, the intake of the solution of the tested compounds versus water was measured and compared.

The two complementary behavioural tests were used in all cases, except for three shy and nocturnal animals, *Haplemur griseus occidentalis*, *Nycticebus pygmaeus* and *Aotus trivirgatus*, where only a two-bottle preference test was employed; with these distrustful species, a *negative* result has to be interpreted very cautiously, particularly with compounds known to have a characteristic aftertaste in man, such as glycine or D-phenylalanine.

All these gustatory studies were made in the Zoological Garden of Zürich, in the Zoological Garden of Frankfurt, in the Parc Zoologique et Botanique of Mulhouse, in the primate facilities of Ciba-Geigy and Hoffmann-LaRoche, Basel, in the Medical Department of the University of Zürich and in the Anthropological Institute of the University of Zürich-Irchel. In some cases, as a control, experiments were duplicated at two different facilities with nine species (*Varecia variegata rubra*, *Callimico goeldii*, *Callithrix jacchus geoffroyi*, *Cebuella pygmaea*, *Leontopithecus rosalia rosalia*, *Gorilla gorilla gorilla*, *Pan troglodytes troglodytes*, *Pongo pygmaeus pygmaeus*, *Pongo pygmaeus abelii*).

Results

While all the compounds tested in these experiments display a sweet taste in humans, the results reported in Table 1 indicate that these compounds can be roughly divided into four different types according to their gustatory responses in non-human primates.

Table 1 Compared gustatory responses of non-human primates (and of *Tupaia*, as an outgroup to primates) to glycine (Gly), D-phenylalanine (D-Phe), D-tryptophan (D-Trp), cyanosuosan, magapame (MAGAP), sucrononate, campame (CAMP), cyclamate (Cyc) and superaspartame (SAPM)

	Gly	D-Phe	D-Trp	Cyano- suosan	MAGAP	Sucro- nonate	CAMP	Cyc	SAPM
Tupaiaidae (outgroup)									
<i>Tupaia belangeri</i>	+	+	+	+	+	+	-	-	+
Lemuridae									
<i>Eulemur coronatus</i>	+	+	+	+	+	+	-	-	-
<i>Eulemur fulvus albifrons</i>	+	+	+	+	+	+	-	-	-
<i>Eulemur macaco macaco</i>	+	+	+	+	+	+	-	-	+
<i>Eulemur macaco flavifrons</i>	+	+	+	+	+	+	-	-	-
<i>Eulemur mongoz</i>	+	+	+	+	+	+	-	-	+
<i>Eulemur rubriventer</i>	+	+	+	+	+	+	-	-	-
<i>Haplemur griseus occidentalis</i>	+	-	+	-	+	+	-	-	-
<i>Lemur catta</i>	+	+	+	+	+	+	-	-	-
<i>Varecia variegata variegata</i>	+	+	+	+	+	+	-	-	-
<i>Varecia variegata rubra</i>	+	+	+	+	+	+	-	-	-
Lorisidae									
<i>Galago senegalensis</i>	-	-	+	+	+	+	-	-	-
<i>Nycticebus pygmaeus</i>	-	-	+	+	+	+	-	-	-
Callitrichidae									
<i>Callimico goeldii</i>	+	+	+	+	+	+	-	-	+
<i>Callithrix jacchus jacchus</i>	+	+	+	+	+	+	-	-	+
<i>Callithrix jacchus geoffroyi</i>	+	+	+	+	+	+	-	-	+
<i>Cebuella pygmaea</i>	+	+	+	+	+	+	-	-	+
<i>Leontopithecus rosalia rosalia</i>	+	+	+	+	+	+	-	-	+
<i>Leontopithecus rosalia chrysomelas</i>	-	+		+	+	+	-	-	+
<i>Saguinus imperator subgrisescens</i>	+	+	+	+	+	+	-	-	-
<i>Saguinus labiatus labiatus</i>	+	+	+	+	+	+	-	-	+
Cebidae									
<i>Aotus trivirgatus</i>	-	-	-	+	+	+	+	-	-
<i>Ateles geoffroyi</i>	+	+	+	+	+	+	+	-	-
<i>Cebus apella xanthosternus</i>	+	+	+	+	+	+	+	-	-
<i>Saimiri sciureus</i>	+	+	±	+	+	+	+	-	-
Cercopithecidae									
<i>Allenopithecus nigroviridis</i>	+	+	+	+	+	+	+	+	+
<i>Cercopithecus diana roloway</i>	+	+	+	+	+	+	+	+	+
<i>Cercopithecus preussi</i>	+	+	+	+	+	+	+	+	+
<i>Erythrocebus patas patas</i>	+	+	+	+	+	+	+	+	+
<i>Macaca arctoides</i>	+	+	+	+	+	+	+	+	+
<i>Macaca nigra</i>	+	+	+	+	+	+	+	+	+
<i>Papio anubis</i>	+	+	+	+	+	+	+	+	+
<i>Papio hamadryas</i>	+	+	+	+	+	+	+	+	+
<i>Papio papio</i>	+	+	+	+	+	+	+	+	+
<i>Presbytis entellus</i>	+	+	+	+	+	+	+	+	+
Hylobatidae									
<i>Hylobates pileatus</i>	+	+	+	+	+	+	+	+	+
<i>Hylobates syndactylus</i>	+	+	+	+	+	+	+	+	+
Pongidae									
<i>Gorilla gorilla gorilla</i>	+	+	+	+	+	+	+	+	+
<i>Pan paniscus</i>	+	+	+	+	+	+	+	+	+
<i>Pan troglodytes troglodytes</i>	+	+	+	+	+	+	+	+	+
<i>Pongo pygmaeus pygmaeus</i>	+	+	+	+	+	+	+	+	+
<i>Pongo pygmaeus abelii</i>	+	+	+	+	+	+	+	+	+

The first category of compounds, comprising Gly, D-Phe, D-Trp, cyanosuosan, MAGAP and sucrononate, are compounds which elicit a sweet taste to practically all primates tested so far (prosimians, New World monkeys and Old World simians).

A second type of compound is CAMPA, which is always unsweet to prosimians and to Callitrichidae, but which is sweet to all Cebidae and to all Old World simians tested so far.

A third type of compound is Cyc, which is unsweet to the non-catarrhine primates and always sweet to Old World simians, just like APM.

A fourth type of compound is SAPM, which is generally unsweet to prosimians, always unsweet to Cebidae, and always sweet to Callitrichidae and to Old World simians.

Note that *Tupaia* (tree shrew), our selected outgroup, responds in the same way as the Callitrichidae to the nine compounds tested in this work (Table 1). Both also respond negatively to APM and ampame, and positively to ALT (unpublished results for the tree shrew).

It should also be noted that *Galago senegalensis* and *Nycticebus pygmaeus* (Lorisidae), two prosimians, respond like the Lemuridae to several compounds tested in this study (Table 1), but also to aspartame (APM⁻) and alitame (ALT⁺) (Glaser *et al.*, 1995a), and to ampame (AMPA⁺) (unpublished results).

Discussion

What molecular features of the primate sweetness receptors can explain these differences of gustatory responses observed within primates? First of all, we will outline some basic points concerning the MPA theory of sweetness reception as developed by two of us to try to understand the structure-activity relationships of sweeteners in man (Nofre and Tinti, 1995, 1996).

According to the MPA theory, it appears that the human sweetness receptor, which is probably a seven-pass transmembrane receptor coupled to a G protein, is formed of eight 'fundamental recognition sites'; these sites are assumed to be able to recognize all the compounds known to be sweet in man, both natural (such as sucrose, fructose or glucose) and artificial ones (such as cyanosuosan or sucrononate). These eight fundamental recognition sites (Figure 10) are assumed to be made up in man: (1) of the side chain of an aspartate (Asp-1) or a glutamate (Glu-1)

residue (through their β - or γ -CO₂⁻ group); (2) of the side chain of a lysine residue (Lys-2) (through its ϵ -NH₃⁺ group); (3) of the side chain of an aspartate (Asp-3) or a glutamate (Glu-3) residue (through their β - or γ -CO₂⁻ group); (4-7) of the side chains of four threonine residues (Thr-4, Thr-5, Thr-6 and Thr-7) (through the OH and CH₃ groups of their CHOHCH₃ side chains); and (8) of the side chain of a serine residue (Ser-8) or, less probably, of a threonine residue (through their β -OH groups). The first seven recognition groups (the 1-CO₂⁻, the 2-NH₃⁺, the 3-CO₂⁻, and the four 4-, 5-, 6- and 7-CHOHCH₃ groups), also called the seven 'basic recognition sites' (they are assumed to be the seven sites capable of recognizing sucrose specifically), are arranged in space approximately according to a skew heptagon (the 'sweetness heptagon') with sides of ~0.65 nm in the activated state of the receptor; the eighth recognition group (the 8-OH group), an extra recognition site which is particularly important for the recognition of certain highly potent artificial sweeteners, is close to Thr-7, ~0.45 nm away (Figure 10).

The first seven recognition sites are each formed of two recognition subsites (or recognition points). These 14 recognition subsites were designated by reference to the labels given to the various interaction points assumed to be involved between sweet compounds and the human sweetness receptor, namely the AH₁- and AH₂-subsites (corresponding to the bidentate CO₂⁻ group of Asp-1 or

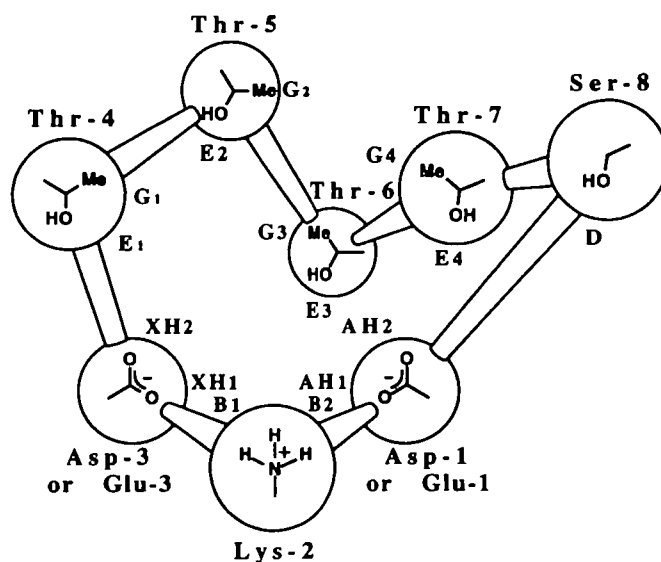

Figure 10 The eight inferred fundamental recognition sites of the human sweetness receptor and the 15 potential interaction points of sweeteners with the human sweetness receptor according to the MPA theory (Nofre and Tinti, 1995, 1996).

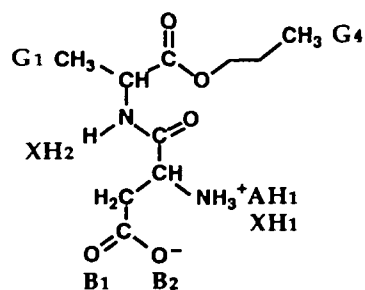

Figure 11 L-Aspartyl-D-alanine propyl ester, a B₁,B₂,AH₁,XH₁,XH₂,G₁,G₄-type sweetener.

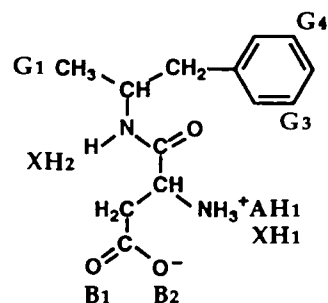

Figure 13 Ampame, a B₁,B₂,AH₁,XH₁,XH₂,G₁,G₃,G₄-type sweetener

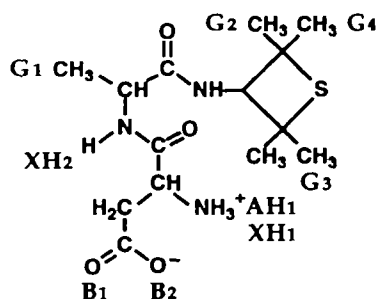

Figure 12 Alitame, a B₁,B₂,AH₁,XH₁,XH₂,G₁,G₂,G₃,G₄-type sweetener.

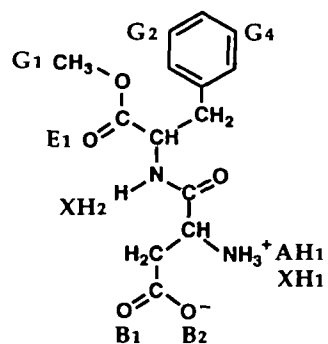

Figure 14 Aspartame, a B₁,B₂,AH₁,XH₁,XH₂,E₁,G₁,G₂,G₄-type sweetener.

Glu-1); the B₁- and B₂-subsites (corresponding to the NH₃⁺ group of Lys-2); the XH₁- and XH₂-subsites (corresponding to the CO₂⁻ group of Asp-3 or Glu-3); the E₁-, E₂-, E₃- and E₄-subsites (corresponding to the OH group of Thr-4, Thr-5, Thr-6 and Thr-7 respectively); and the G₁-, G₂-, G₃- and G₄-subsites (corresponding to the CH₃ group of Thr-4, Thr-5, Thr-6 and Thr-7 respectively). Finally, the eighth recognition site is made up of only one interaction point and is designated as the D-site (corresponding to the OH group of Ser-8) (Figure 10).

At the sweetener level, the points of the sweet molecules that interact with the preceding recognition points of the sweetness receptor are respectively termed as the B₁, B₂, AH₁, AH₂, XH₁, XH₂, E₁, E₂, E₃, E₄, G₁, G₂, G₃, G₄ and D interaction points of the sweetener; note that the number of interaction points of a given sweetener can be equal to or lower than the 15 putative recognition points of the human sweetness receptor. The B₁ and B₂ interaction points are an anionic group (CO₂⁻ or SO₃⁻ for example) or one (or two) hydrogen-bond acceptor atom(s) (two oxygen atoms for example) of a sweetener; the AH₁, AH₂, XH₁ and XH₂ interaction points are hydrogen-bond donor groups (NH⁺, NH, OH) of a sweetener; the E₁, E₂, E₃ and E₄ interaction points are hydrogen-bond acceptor atoms (such as N or O)

of a sweetener; the G₁, G₂, G₃ and G₄ points are steric interaction points (such as CH₃, CH₂ or CH) of a sweetener capable of interacting, through van der Waals contacts, with the CH₃ groups of the threonine recognition sites; finally, the D interaction point is a hydrogen-bond acceptor group (such as CN or NO₂) of a sweetener.

According to the MPA theory, the intermolecular steric interactions between the G-steric interaction points of a sweetener and the G-steric recognition subsites (the threonine CH₃ groups) of the human sweetness receptor are particularly efficient (i) if the interaction gives rise to a very precise *steric fit* of a moiety of the sweetener between at least two threonine methyl groups of the receptor (the sweetener then acting as a wedge leaning on two, or more, opposite CH₃ groups of the receptor); and (ii) if the sterically wedging part of the sweetener is *rigid*; a flexible group is in fact often an inoperative or a weakly operative group. Note that, in the MPA theory, the *steric interaction concept* (and its corollary, the *steric fit concept*) has replaced the former *hydrophobic interaction concept* which is considered as no longer valid (Nofre and Tinti, 1995, 1996; Tinti and Nofre, 1995, 1996).

Recently, we observed that structurally related dipeptide derivatives or analogues, all sweet in man, are able to induce

three types of gustatory response in non-human primates: some of them, such as L-aspartyl-D-alanine propyl ester or alitame, are sweet to all primates (prosimians, New World monkeys and Old World simians); others, such as L-aspartyl-(R)- α -methylphenethylamine (ampame), are sweet to prosimians and Old World simians, but not to New World monkeys; while aspartame is sweet only to Old World simians, but not to prosimians and New World monkeys (Glaser *et al.*, 1995b, 1996).

These gustatory differences between primates can be understood by means of the MPA theory. According to this theory, L-aspartyl-D-alanine propyl ester is, for example, a B₁,B₂,AH₁,XH₁,XH₂,G₁,G₄-type sweetener (Figure 11); alitame a B₁,B₂,AH₁,XH₁,XH₂,G₁,G₂,G₃,G₄-type sweetener (Figure 12); ampame a B₁,B₂,AH₁,XH₁,XH₂,G₁,G₃,G₄-type sweetener (Figure 13); and aspartame a B₁,B₂,AH₁,XH₁,XH₂,E₁,G₁,G₂,G₄-type sweetener (Figure 14). The main steric interaction of the above compounds is essentially the result of a G₁G₄ steric fit. The G₁G₄ steric fit is directly operative only through a sufficiently rigid group, e.g. through the D-alanine propyl ester part of the L-aspartyl-D-alanine propyl ester molecule (Figure 11); the G₁G₄ steric interaction of a highly rigid group can also be reinforced by means of a G₂ and/or a G₃ steric interaction, such as for alitame (Figure 12). With a freely rotating group, e.g. when the G₁G₄ steric interaction is mediated through a benzyl (C₆H₅CH₂) group such as in ampame or aspartame, the G₁G₄ interaction is only operative where the phenyl moiety of the benzyl group can lean on an additional steric subsite of the receptor, through a G₃ steric interaction for ampame, for example (Figure 13), or a G₂ steric interaction for APM (Figure 14).

The preceding interpretation of the mode of interaction of sweet dipeptides at the receptor level permitted us to explain the possible molecular reasons for the gustatory response differences observed in primates. Thus, the lack of the G₂-recognition subsite (the Thr-5 methyl group) in the prosimian and platyrrhine sweetness receptors can explain why APM is not sweet to the non-catarrhine primates, while the lack of the G₃-recognition subsite (the Thr-6 methyl group) in the platyrrhine receptor can explain why ampame is not sweet to the New World primates. On the other hand, the constant presence of the G₁- and G₄-recognition subsites (the Thr-4 and Thr-7 methyl groups) in the sweetness receptors of all primates can explain why L-aspartyl-D-alanine propyl ester or alitame, for example, with their rigid G₁G₄ interacting group, are sweet to all primates tested.

What is the possible nature of the two variable sweetness receptor recognition sites (the fifth and sixth recognition sites) in the non-catarrhine primates? Basing our reasoning on two main criteria, namely (i) necessity of a minimum steric hindrance for the recognition site side chains to allow proper interaction between the sweetener and the receptor, and (ii) preference for a threonine predecessor requiring the most parsimonious change, we thus estimated that the threonine predecessors of the variable fifth or sixth recognition sites could be alanine (Ala) or serine (Ser). As a result, we inferred that the seven basic recognition sites of the sweetness receptor in primates could be (i) in prosimians: Asp-1 or Glu-1, Lys-2, Asp-3 or Glu-3, Thr-4, Ala-5 or Ser-5, Thr-6, Thr-7; (ii) in New World monkeys: Asp-1 or Glu-1, Lys-2, Asp-3 or Glu-3, Thr-4, Ala-5 or Ser-5, Ala-6 or Ser-6, Thr-7; and (iii) in Old World simians: Asp-1 or Glu-1, Lys-2, Asp-3 or Glu-3, Thr-4, Thr-5, Thr-6, Thr-7 (Glaser *et al.*, 1996).

The present work strongly supports the preceding recognition site assignment, while clarifying more specifically the assumed nature of the fifth and sixth recognition sites of the non-catarrhine primates. Moreover, it indicates that the eighth recognition site, which had not been studied in the previous work (Glaser *et al.*, 1996), is also a constant recognition site in primates, like the first, second, third, fourth and seventh recognition sites.

Thus, Gly, which is a B₁,B₂,AH₁,XH₁-type sweetener (Figure 15) according to the MPA theory (Nofre and Tinti, 1995, 1996), is sweet to practically all primates; so this compound must interact with the sweetness receptors of primates through three constant recognition sites: Asp-1 (or Glu-1), Lys-2 and Asp-3 (or Glu-3).

D-Phe and D-Trp, which are also sweet to practically all primates, are both assumed to be B₁,B₂,AH₁,XH₁,G₁-type sweeteners, with their G₁ interaction sites on position 3 of the phenyl ring for D-Phe (Figure 16a) and on position 5 of the indole ring for D-Trp (Figure 16b); consequently, these compounds must interact with the receptors of primates through four constant recognition sites: Asp-1 (or Glu-1), Lys-2, Asp-3 (or Glu-3) and Thr-4.

Cyanosuosan is a B₁,B₂,AH₁,AH₂,D-type sweetener (Figure 17) (Nofre and Tinti, 1995, 1996). As this compound is sweet to practically all primates tested, the D-recognition site (Ser-8) must also be a constant recognition site of the primate sweetness receptors. Cyanosuosan must therefore interact with the receptors of primates through three constant recognition sites: Asp-1 (or Glu-1), Lys-2 and Ser-8.

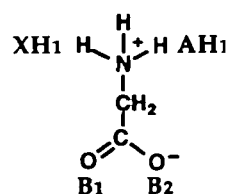

Figure 15 Glycine, a B₁,B₂,AH₁,XH₁-type sweetener.

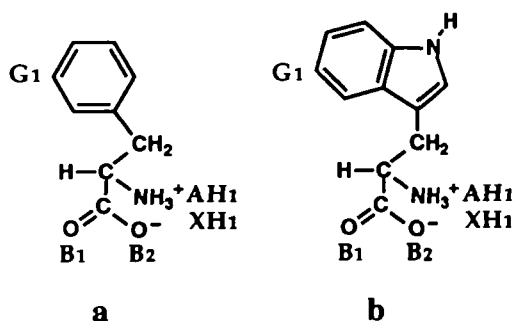

Figure 16 (a) D-phenylalanine and (b) D-tryptophan, two B₁,B₂,AH₁,XH₁,G₁-type sweeteners.

MAGAP is a B₁,B₂,AH₂,XH₂,G₁,E₄,G₄,D-type sweetener (Figure 18) (Tinti and Nofre, 1995, 1996); this compound, which is sweet to all primates tested, must interact with the receptor through six constant recognition sites: Asp-1 (or Glu-1), Lys-2, Asp-3 (or Glu-3), Thr-4, Thr-7 and Ser-8.

Sucronate is a B₁,B₂,AH₂,XH₁,G₁,G₂,G₄,D-type sweetener (Figure 19) (Nofre and Tinti, 1995, 1996). This compound, which is sweet to all primates tested, must therefore interact with the primate receptors essentially through six constant recognition sites, namely Asp-1 (or Glu-1), Lys-2, Asp-3 (or Glu-3), Thr-4, Thr-7 and Ser-8, and, to a lesser degree and only in Old World simians, through Thr-5; the most important steric interaction of this compound with the receptor is, of course, mediated through the G₁G₄ steric fit of its highly rigid cyclononyl ring.

CAMPA is a B₁,B₂,AH₁,AH₂,E₁,E₂,G₁,G₂,D-type sweetener (Figure 20) (Nofre and Tinti, 1995, 1996). This compound, sweet only to Cebidae and Old World simians, must interact with five constant recognition sites, namely Asp-1 (or Glu-1), Lys-2, Asp-3 (or Glu-3), Thr-4 and Ser-8, but also, to be active, through the fifth variable recognition site, Ala-5 or Ser-5 for the cebid receptor and Thr-5 for the catarrhine receptor. Since campame is sweet to Cebidae, the G₂ steric interaction with the fifth recognition site must be a minor interaction, the E₂ polar interaction being alone essential; accordingly, serine (Ser-5), with its OH hydrogen-bond donor group, appears to be the only possible

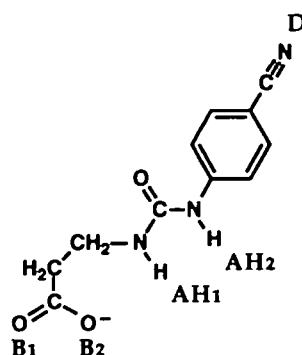

Figure 17 Cyanosuosan, a B₁,B₂,AH₁,AH₂,D-type sweetener.

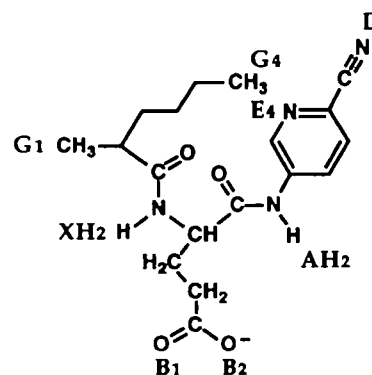

Figure 18 Magapame, a B₁,B₂,AH₂,XH₂,G₁,E₄,G₄,D-type sweetener.

fifth recognition site for the cebid receptor. From campame, which is unsweet to prosimians and Callitrichidae, we can infer that an alanine residue (Ala-5), with its non-polar CH₃ side chain, is the acting fifth recognition site in the prosimian and callitrichid receptors.

For Cyc, the comprehension of its interaction mode with the human sweetness receptor by means of the MPA theory is still questionable, due to insufficient *quantitative* structure–activity relationships in this field. Nevertheless, we estimate that cyclamate could be a B₁,B₂,AH₁,G₂,G₃-type sweetener (Figure 21). If this assignment is correct, we can then estimate that this compound, which is sweet only to Old World simians, must interact with the catarrhine receptor through four recognition sites, namely Asp-1 (or Glu-1), Lys-2, Thr-5 and Thr-6; the two threonine recognition sites must permit a G₂G₃ steric fit of cyclamate (via its cyclohexyl group) between their two CH₃ groups. Consequently, the lack of one (in prosimians) or two (in New World monkeys) threonine residues in the fifth and/or sixth recognition sites of the sweetness receptor of these primates makes any G₂G₃ steric interaction of cyclamate with the non-catarrhine

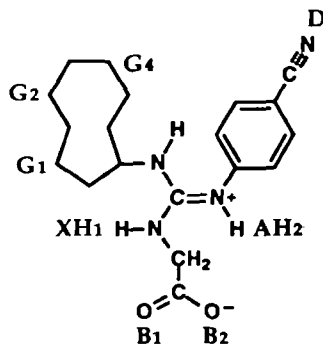

Figure 19 Sucronate, a B₁,B₂,AH₂,XH₁,G₁,G₂,G₄,D-type sweetener.

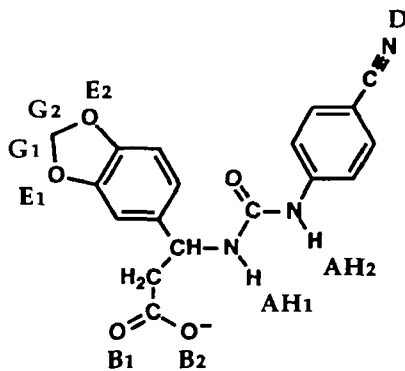

Figure 20 Campame, a B₁,B₂,AH₂,E₁,E₂,G₁,G₂,D-type sweetener.

receptors impossible; this might explain the non-responses of prosimians and New World monkeys to cyclamate.

SAPM, which is a molecular hybrid between APM and cyanosuosan, is a B₁,B₂,AH₁,AH₂,XH₂,E₁,G₁, G₂,G₄,D-type sweetener (Figure 22) (Nofre and Tinti, 1995, 1996). This compound, which is sweet to all the Old World primates tested, must therefore interact with the catarrhine receptor through seven recognition sites: Asp-1 (or Glu-1), Lys-2, Asp-3 (or Glu-3), Thr-4, Thr-5, Thr-7 and Ser-8. SAPM is unsweet to Cebidae, slightly sweet to prosimians (which explains the varied responses observed in this group) and clearly sweet to Callitrichidae. Its action on Callitrichidae could be explained by the existence of two alanine methyl groups (Ala-5 and Ala-6) which would allow an alternative weak steric fit of the SAPM benzyl group.

Thus, our previous and present results, particularly those obtained with APM and AMPA (Glaser *et al.*, 1995b, 1996), and, in the present work, with CAMPA, Cyc and SAPM, show the existence of characteristic dichotomies between the sweetness receptors of several taxonomic groups (Table 2).

As has been analysed, these findings are strongly consistent with the suggested assignment given in Table 3 for the variable fifth and sixth recognition sites, and with the

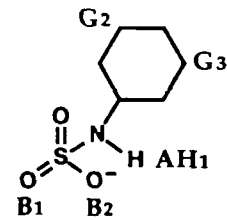

Figure 21 Cyclamate, an assumed B₁,B₂,AH₁,G₂,G₃-type sweetener.

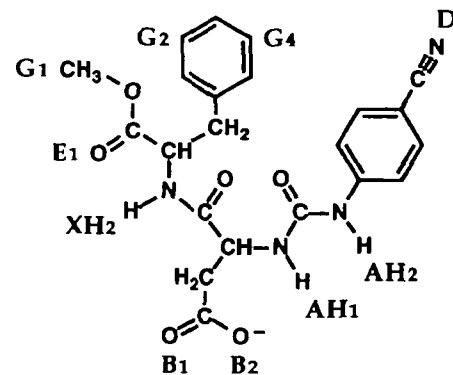

Figure 22 Superspartame, a B₁,B₂,AH₁,AH₂,XH₂,E₁,G₁,G₂,G₄,D-type sweetener.

Table 2 Taxonomic dichotomies observed in gustatory responses of primates with aspartame (APM), ampame (AMPA), campame (CAMP), cyclamate (Cyc) and superspartame (SAPM)

	APM	AMPA	CAMP	Cyc	SAPM
Lemuridae	-	+	-	-	±
Lorisidae	-	+	-	-	-
Callitrichidae	-	-	-	-	+
Cebidae	-	-	+	-	-
Cercopithecidae	+	+	+	+	+
Hylobatidae	+	+	+	+	+
Pongidae	+	+	+	+	+
Hominidae	+	+	+	+	+

+ refers to a preference for the compound tested, - to an indifference or rejection, ± to varied responses within the group (probably due to a weak interaction of the compound with the sweetness receptor).

following organization (as outlined in Figure 23) of the primate sweetness receptors: (1) for prosimians (Lemuridae and Lorisidae): Asp-1 (or Glu-1), Lys-2, Asp-3 (or Glu-3), Thr-4, Ala-5, Thr-6, Thr-7, Ser-8; (2) for Callitrichidae: Asp-1 (or Glu-1), Lys-2, Asp-3 (or Glu-3), Thr-4, Ala-5, Ala-6, Thr-7, Ser-8; (3) for Cebidae: Asp-1 (or Glu-1), Lys-2, Asp-3 (or Glu-3), Thr-4, Ser-5, Ala-6, Thr-7, Ser-8; and (4) for Old World simians (Cercopithecidae,

Table 3 Inferred assignments of the variable fifth (X-5) and sixth (X-6) recognition sites of the primate sweetness receptors

	X-5	X-6
Lemuridae	Ala	Thr
Lorisidae	Ala	Thr
Callitrichidae	Ala	Ala
Cebidae	Ser	Ala
Cercopitheciidae	Thr	Thr
Hylobatidae	Thr	Thr
Pongidae	Thr	Thr
Hominidae	Thr	Thr

Ala refers to alanine, Ser to serine and Thr to threonine.

Hylobatidae, Pongidae and Hominidae): Asp-1 (or Glu-1), Lys-2, Asp-3 (or Glu-3), Thr-4, Thr-5, Thr-6, Thr-7, Ser-8.

The above inferred assignments for the variable fifth (X-5) and sixth (X-6) recognition sites of the primate sweetness receptors suggest the existence in primates of four types of sweetness receptor, namely (i) the prosimian receptor, which would be an Ala-5/Thr-6 receptor (or an A5/T6 receptor if we use the conventional one-letter abbreviations of the amino acids); (ii) the callitrichid receptor, which would be an Ala-5/Ala-6 (or an A5/A6) receptor; (iii) the cebid receptor, which would be a Ser-5/Ala-6 (or a S5/A6) receptor; and (iv) the Old World simian receptor, which would be a Thr-5/Thr-6 (or a T5/T6) receptor (Table 4).

By reasoning on a molecular basis, the replacement of an alanine residue by a serine (Ala → Ser) or a threonine (Ala → Thr) residue in a sweetness receptor leads to an increase in the *structural complexity* of the receptors (Figure 24). As a result, these changes lead to an increase in the *functional complexity* of the receptors, as can be seen by comparing (i) the steric interaction potentialities of the platyrrhine receptor with those of the prosimian or catarrhine receptors (Figure 25), and (ii) the hydrogen-bonding bridge possibilities of the upper region of the sweetness receptor model for the callitrichid receptor with regard to the cebid, prosimian or catarrhine receptors (Figure 26).

Moreover, the tree shrew (*Tupaia belangeri*, family Tupaiidae, order Scandentia), a species very closely related to primates (see e.g. Luckett, 1980; Martin, 1990) that we selected for an outgroup comparison (to try to infer which primate receptor may have retained the most primitive state, and to root the inferred phylogenetic tree and fix the common ancestral node) (see e.g. Stevens, 1980; Maddison et al., 1984), makes the same gustatory responses towards all the tested sweeteners as the Callitrichidae. Thus, the tree

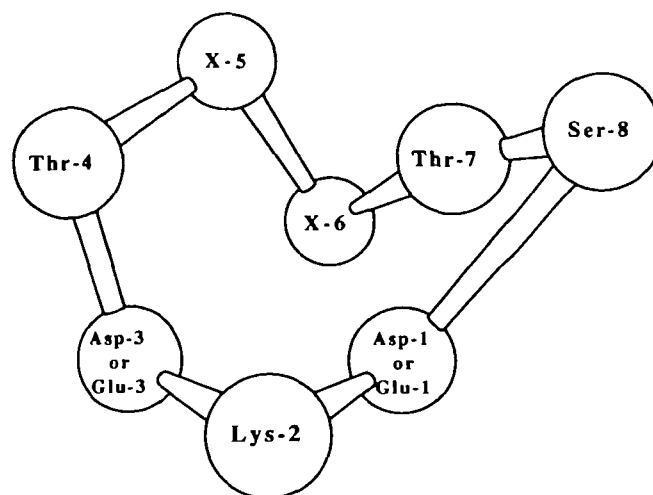
**Figure 23** Putative organization of the primate sweetness receptors. The fifth (X-5) and sixth (X-6) variable recognition sites are inferred from the present work and from the MPA theory to be: (1) in prosimians (Lemuridae and Lorisidae): Ala-5 and Thr-6; (2) in Callitrichidae: Ala-5 and Ala-6; (3) in Cebidae: Ser-5 and Ala-6; and (4) in Old World simians (Cercopitheciidae, Hylobatidae, Pongidae and Hominidae): Thr-5 and Thr-6 (see Table 3).**Table 4** The four different types of primate sweetness receptor as proposed from their inferred fifth and sixth reception sites (amino-acid notation)

Taxonomic group	Three-letter notation	One-letter notation
Prosimians	Ala-5/Thr-6	A5/T6
Callitrichidae	Ala-5/Ala-6	A5/A6
Cebidae	Ser-5/Ala-6	S5/A6
Old World simians	Thr-5/Thr-6	T5/T6

In the one-letter abbreviations of the amino acids, A refers to alanine, S to serine, and T to threonine.

shrew, like the Callitrichidae, is APM⁻, ALT⁺ and AMPA⁻ (unpublished results), and also CAMPA⁻, Cyc⁻ and SAPM⁺ (see Table 1). These data are consistent with an A5/A6-type sweetness receptor for the Tupaiidae, and, by inference, support the view that the callitrichid A5/A6-type receptor has retained the most primitive state among the four types of primate receptor.

All the above observations are therefore strongly in favour of the retention of a primitive (plesiomorphic) character state by the callitrichid receptor, which could represent an accurate image of the ancestral primate stock receptor. The catarrhine receptor is obviously the most advanced one among the primate receptors, while the cebid and prosimian receptors represent intermediary advancement states.

At the DNA level of the genes encoding the sweetness

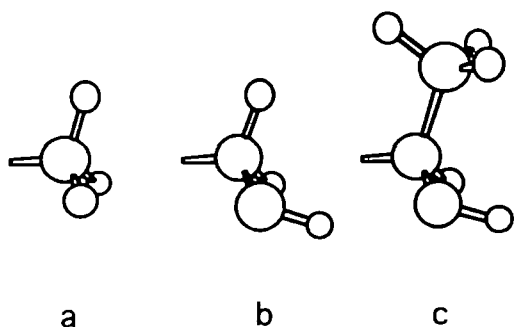

Figure 24 Ball-and-stick models of the (a) alanine, (b) serine and (c) threonine side chains, where (a) is CH₃, (b) CH₂OH, and (c) CHOCH₃.

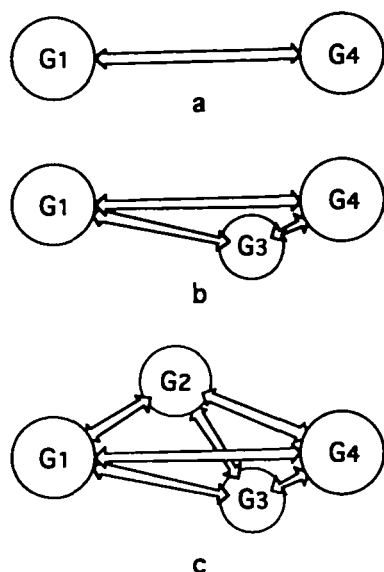

Figure 25 The various possibilities of interaction of a sweetener through steric interactions (steric fits) for the (a) platyrrhine, (b) prosimian and (c) catarrhine sweetness receptors, in order of increasing complexity (Glaser *et al.*, 1996).

receptor proteins, if we apply the well-known coding relations between DNA and amino acids, the replacement of an alanine by a serine residue (Ala → Ser) in a recognition site of the sweetness receptor requires a guanine → thymine (G → T) transversion in the corresponding non-transcribed trinucleotide sequence of the related sweetness receptor gene, and the replacement of an alanine by a threonine residue (Ala → Thr) requires a guanine → adenine (G → A) transition in the corresponding non-transcribed trinucleotide sequence of the related gene. As a result, the two trinucleotide sequences that code the fifth/sixth recognition sites of each receptor type could be: in prosimians, GCN-5/ACN-6; in Callitrichidae, GCN-5/GCN-6; in Cebidae, TCN-5/GCN-6; in Old World simians, ACN-5/

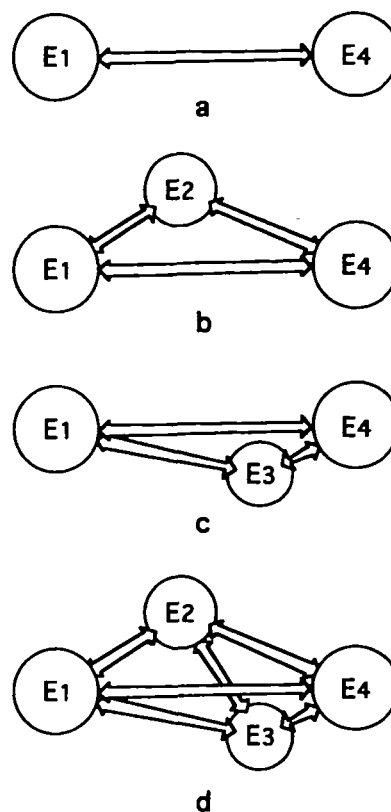

Figure 26 The various possibilities of interaction of a sweetener through hydrogen-bond bridges with the upper region of the sweetness receptor model for the (a) callitrichid, (b) cebid, (c) prosimian and (d) catarrhine receptors, in order of increasing complexity.

Table 5 The four different types of primate sweetness receptor gene as defined from the nucleotides able to specify the inferred fifth and sixth recognition sites (nucleotide notation).

Taxonornic group	Trinucleotide notation	First-position nucleotide notation
Prosimians	GCN-5/ACN-6	G5/A6
Callitrichidae	GCN-5/GCN-6	G5/G6
Cebidae	TCN-5/GCN-6	T5/G6
Old World simians	ACN-5/ACN-6	A5/A6

A, C, G and T refer to nucleotides whose bases are adenine, cytosine, guanine and thymine respectively. N refers to a nucleotide which is a 4-fold degenerate site and which can then be indifferently A, C, G or T. The sequences of DNA nucleotides are given at the level of the non-transcribed strand, according to the conventional left-to-right direction (5' end → 3' end). Note that two other additional codons are known for Ser (AGT and AGC), as these two codons each need at least two substitutions to be formed from the Ala codons, their direct

ACN-6 (where A represents a nucleotide with adenine, C with cytosine, G with guanine, T with thymine, and N, a nucleotide with adenine, cytosine, guanine or thymine,

indifferently) (Table 5). Since it appears that the non-synonymous mutations always affect the first-position nucleotide of the above trinucleotide sequences, it follows that the different sweetness receptors of primates can also be concisely designated, in an alternative nucleotide notation based on the inferred mutations of the respective genes, as: G5/A6 for the prosimians; G5/G6 for the Callitrichidae; T5/G6 for the Cebidae; A5/A6 for the Old World simians (where A represents a nucleotide with adenine, G with guanine and T with thymine).

What are the possible taxonomic and phylogenetic implications of these findings?

According to the inferred assignments given to the fifth and sixth recognition sites of the primate sweetness receptors, it follows that the most parsimonious phylogenetic relationships linking these receptors should be those shown in Figure 27, where the primates studied in the present work are divided into four clades (monophyletic groups), namely Callitrichidae, Cebidae, Prosimii (Lemuridae and Lorisidae), and Catarrhini (Old World simians). The maximum-parsimony tree (cladogram) so obtained disagrees with the current and dominant opinions concerning the evolution of primates (see e.g. Gingerich, 1984; Rosenberger, 1986; Harrison, 1987; Hayasaka *et al.*, 1988; Koop *et al.*, 1989; Martin, 1990, 1993; Miyamoto and Goodman, 1990; Ford, 1994; Porter *et al.*, 1995), which always suppose a monophyly for the Anthropeoidea. In fact, this cladogram implies that Anthropeoidea are *diphyletic*, and supposes an *independent evolution* of the New World monkeys (parallel and convergent to the Old World simians) as a result of the continental drift between Africa and South America; this view was formerly advocated by Hershkovitz (1977) and others (e.g. Le Gros Clark, 1971; Groves, 1972; Cachel, 1981; Glaser *et al.*, 1996). Such a scenario has the advantage of furnishing better comprehension concerning the much debated geographical origin of the New World monkeys and of making unnecessary the unconvincing explanations proposed for their immigration to South America, such as by rafting across the South Atlantic from Africa, which is, despite its high unlikelihood (see Simpson, 1978), the hypothesis still the most frequently put forward (e.g. Fleagle, 1986, 1988).

Whatever the evolutionary scenario involved, the fact remains that prosimians, Cebidae and, above all, Old World simians possess the most advanced types of sweetness receptor as compared with that of Callitrichidae, considered to be the most primitive and inferred to be representative of

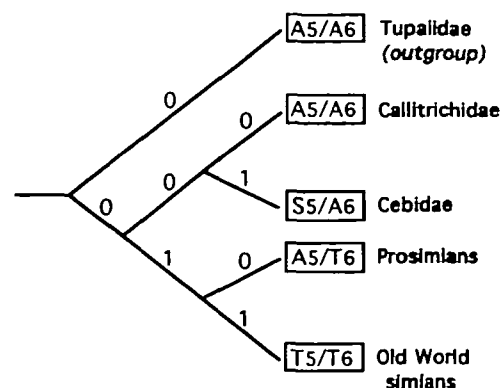

Figure 27 Phylogeny of sweetness reception in primates: the most parsimonious solution. The number beside each branch indicates the number of inferred substitutions (0 or 1) from the nearest branching point (divergence node); in other words, 0 indicates the retention of a previous primitive (plesiomorphic) state; 1 indicates a change to a derived (apomorphic) state. A refers to alanine, S to serine and T to threonine. Tupaiaidae (order Scandentia) have been introduced for outgroup comparison. The primitive primate receptor is inferred to be an A5/A6-type receptor.

the ancestral primate receptor. We suppose that this sophistication of the sweetness receptors, from the most primitive (plesiomorphic) state to the derived (apomorphic) states, is principally due to a significant improvement in their ability to detect and select soluble carbohydrates, essentially fructose and sucrose. In fact, as inferred from the MPA theory, fructose is an E_1, E_2, E_3, E_4 -type sweetener, and sucrose a $B_1, B_2, AH_1, AH_2, XH_1, XH_2, E_1, G_1, E_2, G_2, E_3, G_3, E_4, G_4$ -type sweetener in humans (Nofre and Tinti, 1995, 1996), and, by extension, in the whole Catarrhini. In the Callitrichidae (as well as in the Tupaiaidae, our reference outgroup, or in the putative primate ancestors), fructose should interact as an E_1, E_4 -type sweetener, and sucrose as a $B_1, B_2, AH_1, AH_2, XH_1, XH_2, E_1, G_1, E_4, G_4$ -type sweetener. In the Cebidae, fructose should interact as an E_1, E_2, E_4 -type sweetener, and sucrose as a $B_1, B_2, AH_1, AH_2, XH_1, XH_2, E_1, G_1, E_2, E_4, G_4$ -type sweetener. In the Prosimii, fructose should interact as an E_1, E_3, E_4 -type sweetener, and sucrose as a $B_1, B_2, AH_1, AH_2, XH_1, XH_2, E_1, G_1, E_3, G_3, E_4, G_4$ -type sweetener. For D-glucose, another soluble carbohydrate, which is a $B_1, B_2, AH_1, AH_2, XH_1, XH_2$ -type sweetener in humans (Nofre and Tinti, 1995, 1996), there should be no differences of interaction between the callitrichid, cebid, prosimian or catarrhine receptors, since D-glucose is assumed to interact through a constant part (the first, second and third recognition sites) of the primate receptors.

In conclusion, we believe that the sophistication of the sweetness receptor, such as we find it in Cebidae and, above

all, in Old World simians, was a key factor involved in raising primates from a 'primitive grade' towards a more 'advanced' or 'simian grade', probably by favouring the change from a typically insect-based diet (such as we still find in the modern Tupaiidae or Callitrichidae, or, to a lesser degree, in certain prosimians) to a diet essentially based on fruit or on other plant materials (such as we find in the Cebidae and in the Old World simians).

Finally, we think that the appearance >35 million years

ago (Gingerich, 1984, 1986), in the ancestral stock of the Old World simians, of an innovative sweetness receptor that was remarkably adapted to the specific detection of fructose and sucrose must have been a major transition in the catarrhine evolution, by improving food search efficiency and dietary choice of these primates for highly energetic nutriment, especially fruit, which could have favoured, as stated previously (Glaser *et al.*, 1995a), their mental development, and, later, the emergence of humans.

ACKNOWLEDGEMENTS

We would like to thank Anne-Marie Peytavi, Edith Juvin, Odile Sarcelle and Edith Le Bredonchel, of Université Claude Bernard, Lyon, for their contributions to this work. The authors are also grateful to the following for making experimental animals available and for their kind support or assistance in carrying out the experiments: Professor H. Blum and Dr E. Walter, Klinikum der Albert Ludwigs Universität, Freiburg im Breisgau, Germany (*Tupaia belangeri*); J.J.C. Mallinson, Director, The Jersey Wildlife Preservation Trust (*Callimico goeldii*); Dr A. Rübel, Director, Zoological Garden, Zürich, Switzerland, and head keepers, K. Rathfelder, P. Oberhänkli, R. Erni, R. Züst; Dr C.R. Schmidt, Director, Zoological Garden, Frankfurt, Germany, and head keepers F. Stadtmüller, H. Klose, K. Krumbholz; Dr J.-M. Lernoald, Director, Parc Zoologique et Botanique, Mulhouse, France, and head keeper J.-P. Weynacht; Mrs Monika Huber, med. vet. (F. Hoffmann-LaRoche AG, Basel, Switzerland). The present research was supported by the NutraSweet Company, Deerfield, IL, USA, and is a contribution to a European Union project: 'The Mechanistic Understanding of the Sweetness Response' (AIR3-CT94-2107). It was further supported by a grant from the 'Bundesamt für Bildung und Wissenschaft' (BBW Nr. 94.0156), Bern, Switzerland.

REFERENCES

- Audrieth, L.F. and Sveda, M. (1944) Preparation and properties of some *N*-substituted sulfamic acids. *J. Org. Chem.*, **9**, 89–101.
- Cachel, S.M. (1981) Plate tectonics and the problem of anthropoid origins. *Yearbook Phys. Anthropol.*, **24**, 139–172.
- Conroy, G.C. (1990) *Primate Evolution*. Norton, New York, pp. 393–403.
- Corbet, G.B. and Hill, J.E. (1991) *A World List of Mammalian Species*, 3rd edn. Oxford University Press, Oxford, pp. 39–40.
- Fleagle, J.G. (1986) Early anthropoid evolution in Africa and South America. In Else, J.G. and Lee, P.C. (eds), *Primate Evolution*. Cambridge University Press, Cambridge, Vol. 1, pp. 133–142.
- Fleagle, J.G. (1988) *Primate Adaptation and Evolution*. Academic Press, San Diego, pp. 351–361.
- Ford, S.M. (1994) Primitive platyrrhines? Perspectives on anthropoid origins from platyrrhine, parapihcedid, and preanthropoid postcrania. In Fleagle, J.G. and Kay, R.F. (eds), *Anthropoid Origins*. Plenum Press, New York, pp. 595–673.
- Gingerich, P.D. (1984) Primate evolution: evidence from the fossil record, comparative morphology, and molecular biology. *Yearbook Phys. Anthropol.*, **27**, 57–72.
- Gingerich, P.D. (1986) Temporal scaling of molecular evolution in primates and other mammals. *Mol. Biol. Evol.*, **3**, 205–221.
- Glaser, D., Tinti, J.M. and Nofre, C. (1995a) Evolution of the sweetness receptor in primates. I. Why does alitame taste sweet in all prosimians and simians, and aspartame only in Old World simians? *Chem. Senses*, **20**, 573–584.
- Glaser, D., Tinti, J.M. and Nofre, C. (1995b) Gustatory responses of non-human primates to dipeptide derivatives or analogues sweet in man. *Sweet Taste Chemoreception: 2nd ECRO Sweetness Symposium* (August 29–September 1, 1995). University of Reading, Reading, UK.
- Glaser, D., Tinti, J.M. and Nofre, C. (1996) Gustatory responses of non-human primates to dipeptide derivatives or analogues sweet in man. *Food Chem.*, **56**, 313–321.
- Groves, C.P. (1972) Phylogeny and classification of primates. In Fiennes, R.N. T-W- (ed.), *Pathology of Simian Primates, Part I: General Pathology*. Karger, Basel, pp. 11–57.

- Harrison, T. (1987) The phylogenetic relationships of the early catarrhine primates: a review of the current evidence. *J. Hum. Evol.*, **16**, 41–80.
- Hayasaka, K., Gojobori, T. and Horai, S. (1988) Molecular phylogeny and evolution of primate mitochondrial DNA. *Mol. Biol. Evol.*, **5**, 626–644.
- Hershkovitz, P. (1977) *Living New World Monkeys (Platyrrhini)*. University of Chicago Press, Chicago, Vol. 1, pp. 67–72.
- Koop, B.F., Tagle, D.A., Goodman, M. and Slightom, J.L. (1989) A molecular view of primate phylogeny and important systematic and evolutionary questions. *Mol. Biol. Evol.*, **6**, 580–612.
- Le Gros Clark, W.E. (1971) *The Antecedents of Man*. Edinburgh University Press, Edinburgh.
- Luckett W.P. (1980) The suggested evolutionary relationships and classification of tree shrews. In Luckett, W.P. (ed.), *Comparative Biology and Evolutionary Relationships of Tree Shrews*. Plenum Press, New York, pp. 3–31.
- Maddison, W.P., Donoghue, M.J. and Maddison, D.R. (1984) Outgroup analysis and parsimony. *Syst. Zool.*, **33**, 83–103.
- Madigan, D.L., Muller, G.W., Walters, D.E., Culberson, J.C., DuBois, G.E., Carter, J.S., Nagarajan, S., Klix, R.C., Ager, D.J. and Klade, C.A. (1989) Substituted aryl ureas as high potency sweeteners. European Patent Application 0 355 819 A1 (August 23, 1989).
- Martin, R.D. (1990) *Primate Origins and Evolution: A Phylogenetic Reconstruction*. Chapman and Hall, London.
- Martin, R.D. (1993) Primate origins: plugging the gaps. *Nature*, **363**, 223–234.
- Miyamoto, M.M. and Goodman, M. (1990) DNA systematics and evolution of primates. *Annu. Rev. Ecol. Syst.*, **21**, 197–220.
- Muller, G.W., Madigan, D.L., Culberson, J.C., Walters, D.E., Carter, J.S., Klade, C.A., DuBois, G.E. and Kellog, M.S. (1991) High-potency sweeteners derived from β -amino acids. In Walter, D.E., Orthofer, F.T. and DuBois, G.E. (eds), *Sweeteners: Discovery, Molecular Design, and Chemoreception*. American Chemical Society, Washington, DC, pp. 113–125.
- Nofre, C. and Tinti, J.M. (1987) Sweetening agents. US Patent 4 645 678 (February 24, 1987).
- Nofre, C. and Tinti, J.M. (1994) Sweetening agent derived from L-aspartic or L-glutamic acid. US Patent 5 310 908 (May 10, 1994).
- Nofre, C. and Tinti, J.M. (1995) Sweetness reception in man: the multipoint attachment theory. *Sweet Taste Chemoreception: 2nd ECRO Sweetness Symposium* (August 29–September 1, 1995). The University of Reading, Reading, UK.
- Nofre, C. and Tinti, J.M. (1996) Sweetness reception in man: the multipoint attachment theory. *Food Chem.*, **56**, 263–274.
- Nofre, C., Tinti, J.M. and Chatzopoulos Ouar, F. (1990) Sweetening agents. US Patent 4 921 939 (May 1, 1990).
- Petersen, S. and Müller, E. (1948) Über eine neue gruppe von süßstoffen. *Chem. Ber.*, **81**, 31–38.
- Porter, C.A., Sampaio, I., Schneider, H., Schneider, M.P., Czelusniak, J. and Goodman, M. (1995) Evidence on primate phylogeny from ϵ -globin gene sequences and flanking regions. *J. Mol. Evol.*, **40**, 30–55.
- Rosenberger, A.L. (1986) Platyrrhines, catarrhines and the anthropoid transition. In Wood, B., Martin, L. and Andrews, P. (eds), *Major Topics in Primate and Human Evolution*. Cambridge University Press, Cambridge, pp. 66–88.
- Simons, E.L. (1972) *Primate Evolution: An Introduction to Man's Place in Nature*. Macmillan, New York.
- Simpson, G.G. (1978) Early mammals in South America: fact, controversy, and mystery. *Proc. Am. Philos. Soc.*, **122**, 318–328.
- Steiner, J.E. and Glaser, D. (1984) Differential behavioral responses to taste stimuli in non-human primates. *J. Hum. Evol.*, **13**, 709–723.
- Steiner, J.E. and Glaser, D. (1995) Taste-induced facial expressions in apes and humans. *J. Hum. Evol.*, **10**, 97–105.
- Stevens, P.F. (1980) Evolutionary polarity of character states. *Annu. Rev. Ecol. Syst.*, **11**, 333–358.
- Tinti, J.M., Nofre, C. and Peytavi, A.M. (1982) Interaction of suosan with the sweet taste receptor, *Z. Lebensm. Unters. Forsch.*, **175**, 266–268.
- Tinti, J.M. and Nofre, C. (1995) New high-potency sweeteners. *Contribution of Low- and Non-Volatile Materials to the Flavor of Foods*, 210th American Chemical Society Symposium (August 20–24, 1995), Chicago.
- Tinti, J.M. and Nofre, C. (1996) New high-potency sweeteners. In Pickenhagen, W., Chi-Tang Ho and Spanier, A.M. (eds), *Contribution of Low- and Non-Volatile Materials to the Flavor of Foods*. Allured, Carol Stream, IL, in press.
- Wilson, D.E. (1993) Order Scandentia. In Wilson, D.E. and Reeder, D.M. (eds), *Mammal Species of the World: A Taxonomic and Geographic Reference*, 2nd edn. Smithsonian Institution Press, Washington, DC, pp. 131–133.

Received April 23, 1996; accepted June 19, 1996